

<http://poloclub.gatech.edu/cse6242>

CSE6242 / CX4242: **Data** & **Visual** Analytics

Time Series

Non-linear Forecasting

Duen Horng (Polo) Chau

Associate Professor

Associate Director, MS Analytics

Machine Learning Area Leader, College of Computing

Georgia Tech

Partly based on materials by

Professors Guy Lebanon, Jeffrey Heer, John Stasko, Christos Faloutsos, Parishit Ram (GT PhD alum; SkyTree), Alex Gray

Chaos & non-linear forecasting

Reference:

[Deepay Chakrabarti and Christos Faloutsos
*F4: Large-Scale Automated Forecasting using
Fractals* CIKM 2002, Washington DC, Nov.
2002.]

Detailed Outline

- Non-linear forecasting
 - Problem
 - Idea
 - How-to
 - Experiments
 - Conclusions

Recall: Problem #1

Value

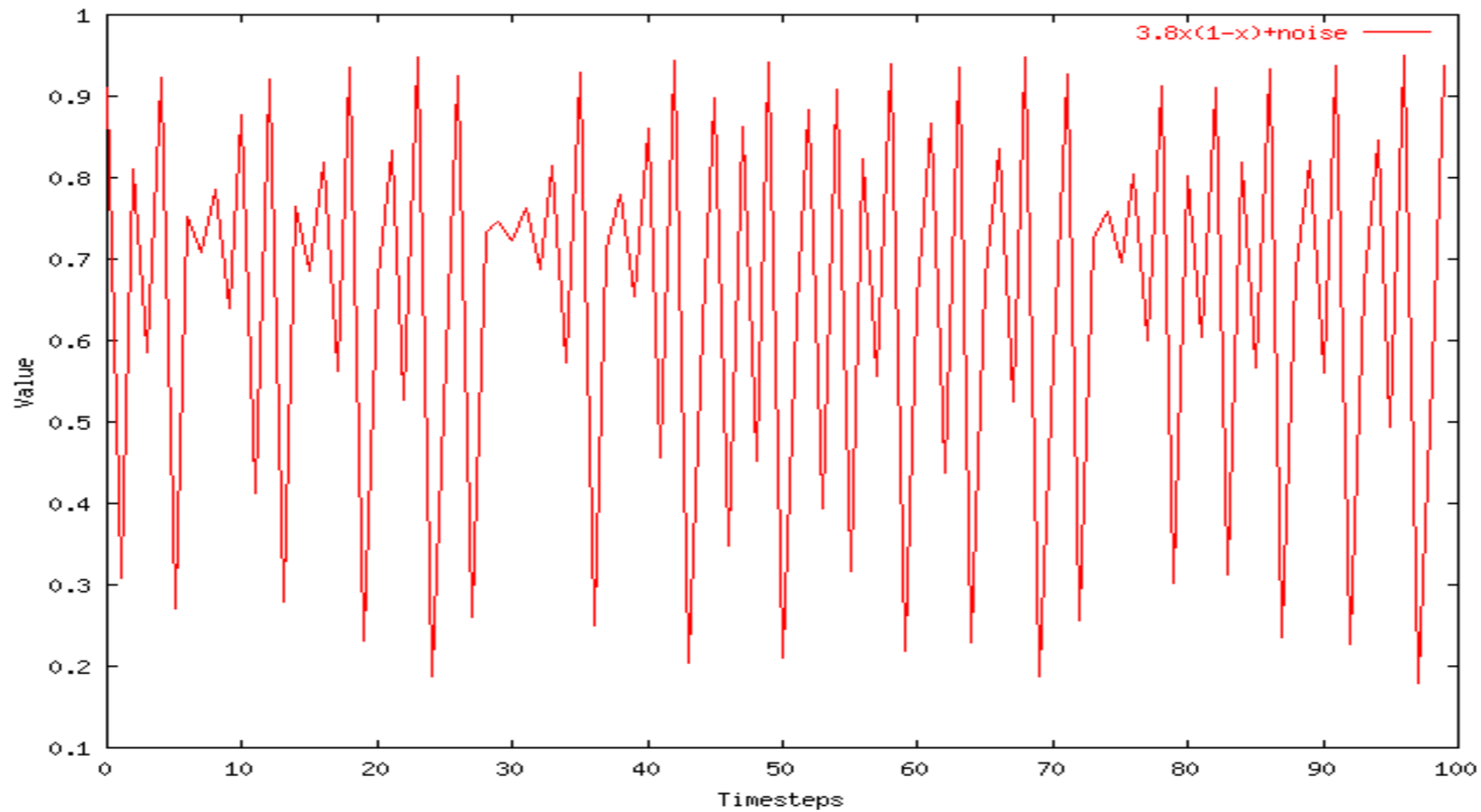

Time

Given a time series $\{x_t\}$, predict its future course, that is, x_{t+1} , x_{t+2} , ...

Datasets

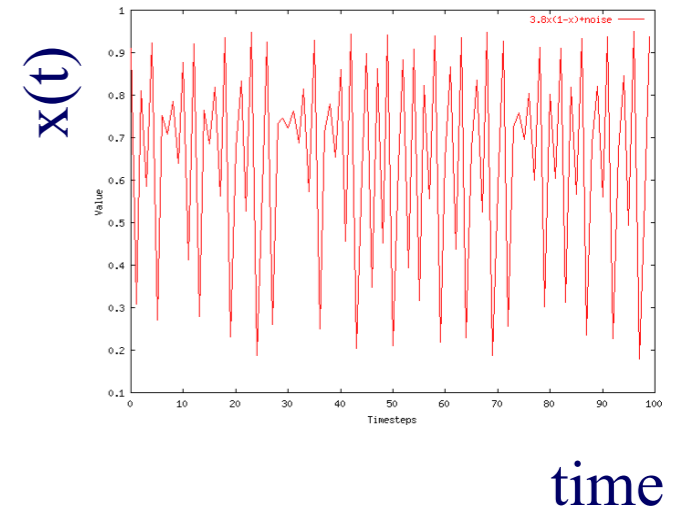

Logistic Parabola:

$$x_t = ax_{t-1}(1-x_{t-1}) + \text{noise}$$

Models population of flies [R. May/1976]

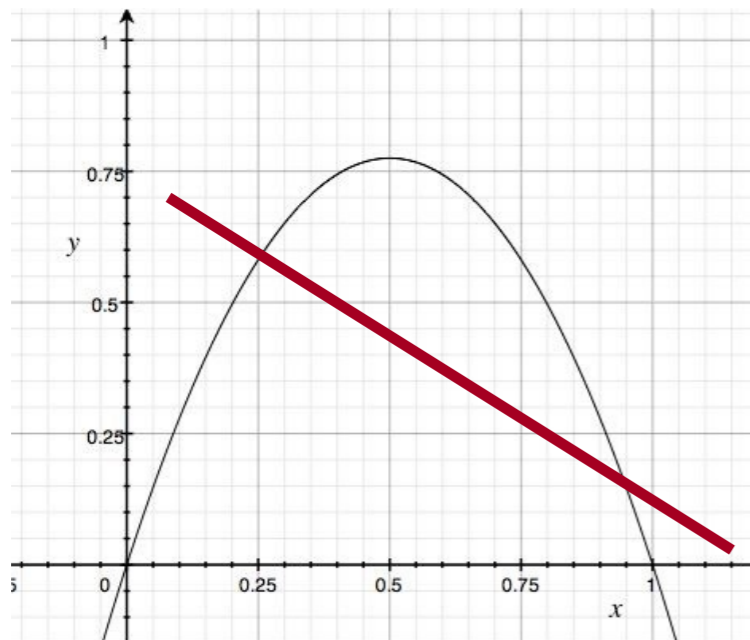

Lag-plot

ARIMA: fails

How to forecast?

- ARIMA - but: linearity assumption

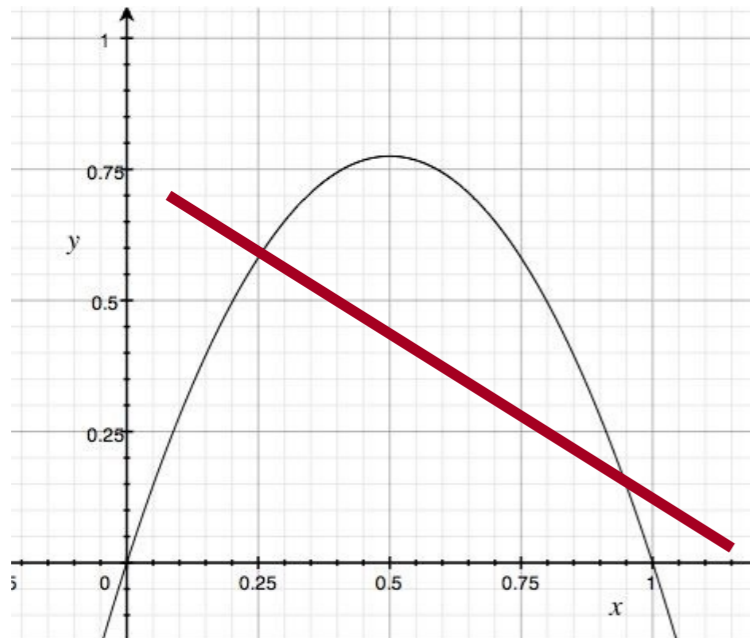

Lag-plot
ARIMA: fails

How to forecast?

- ARIMA - but: linearity assumption
- ANSWER: ‘Delayed Coordinate Embedding’
= Lag Plots [Sauer92]
~ nearest-neighbor search, for past incidents

General Intuition (Lag Plot)

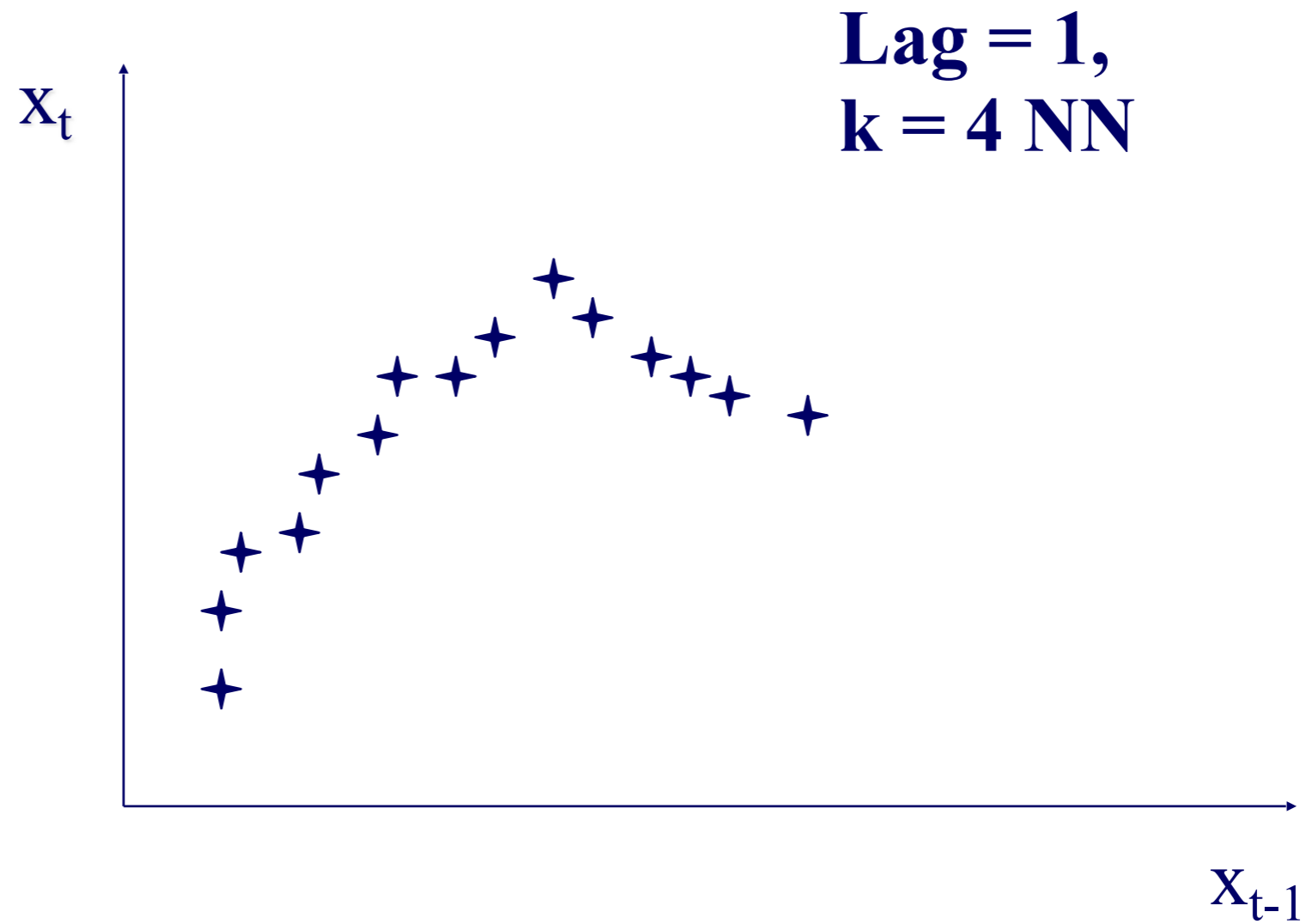

General Intuition (Lag Plot)

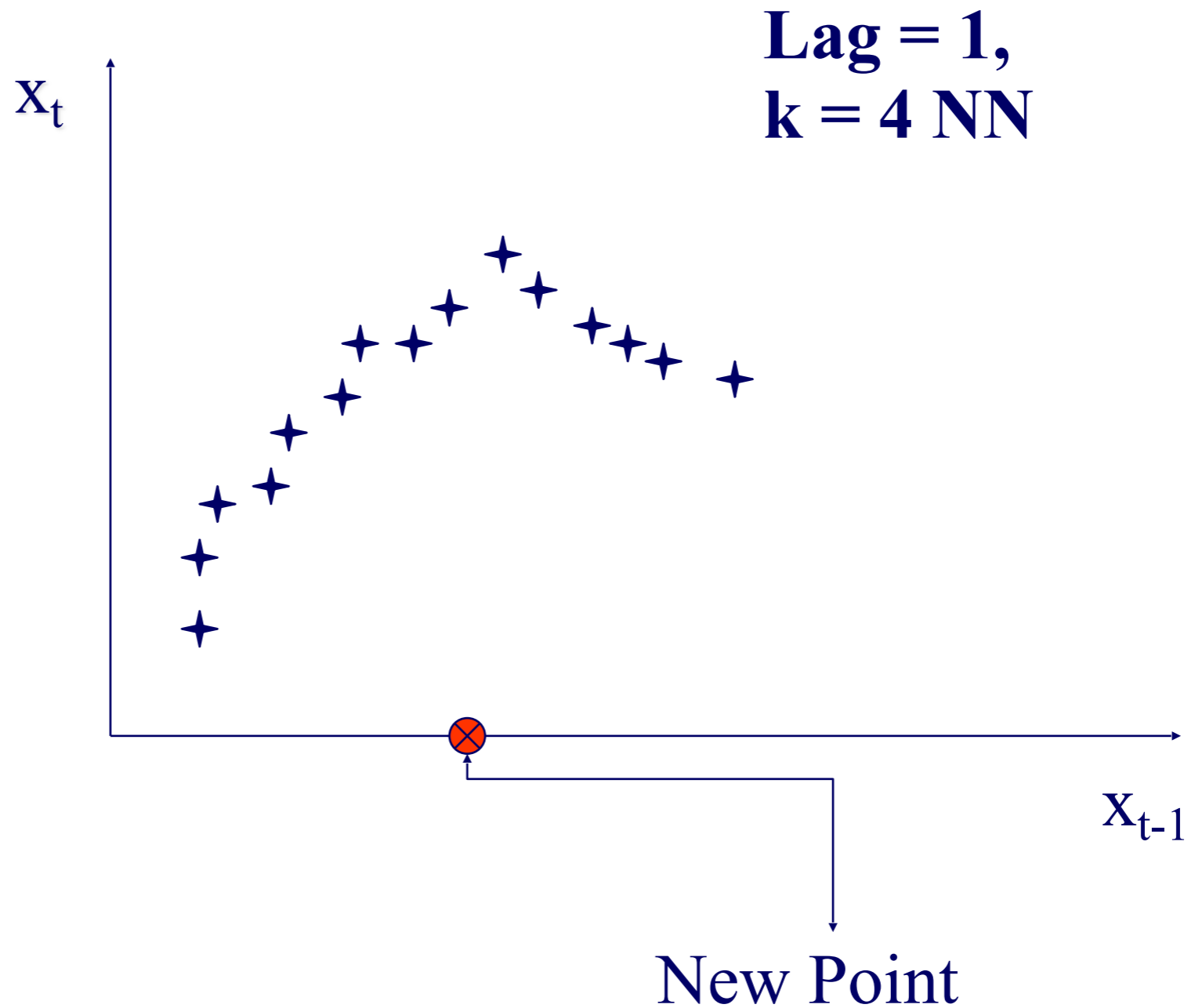

General Intuition (Lag Plot)

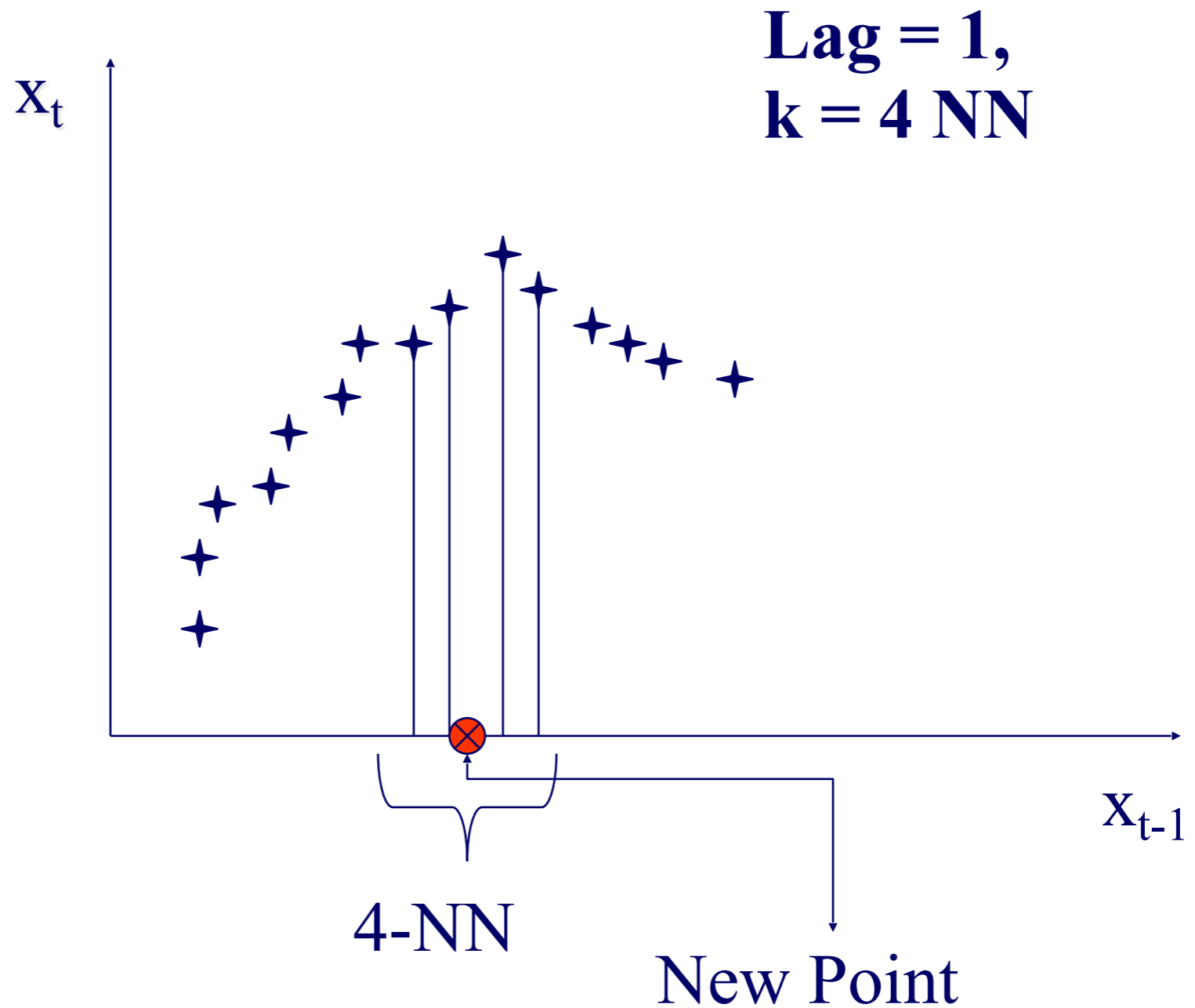

General Intuition (Lag Plot)

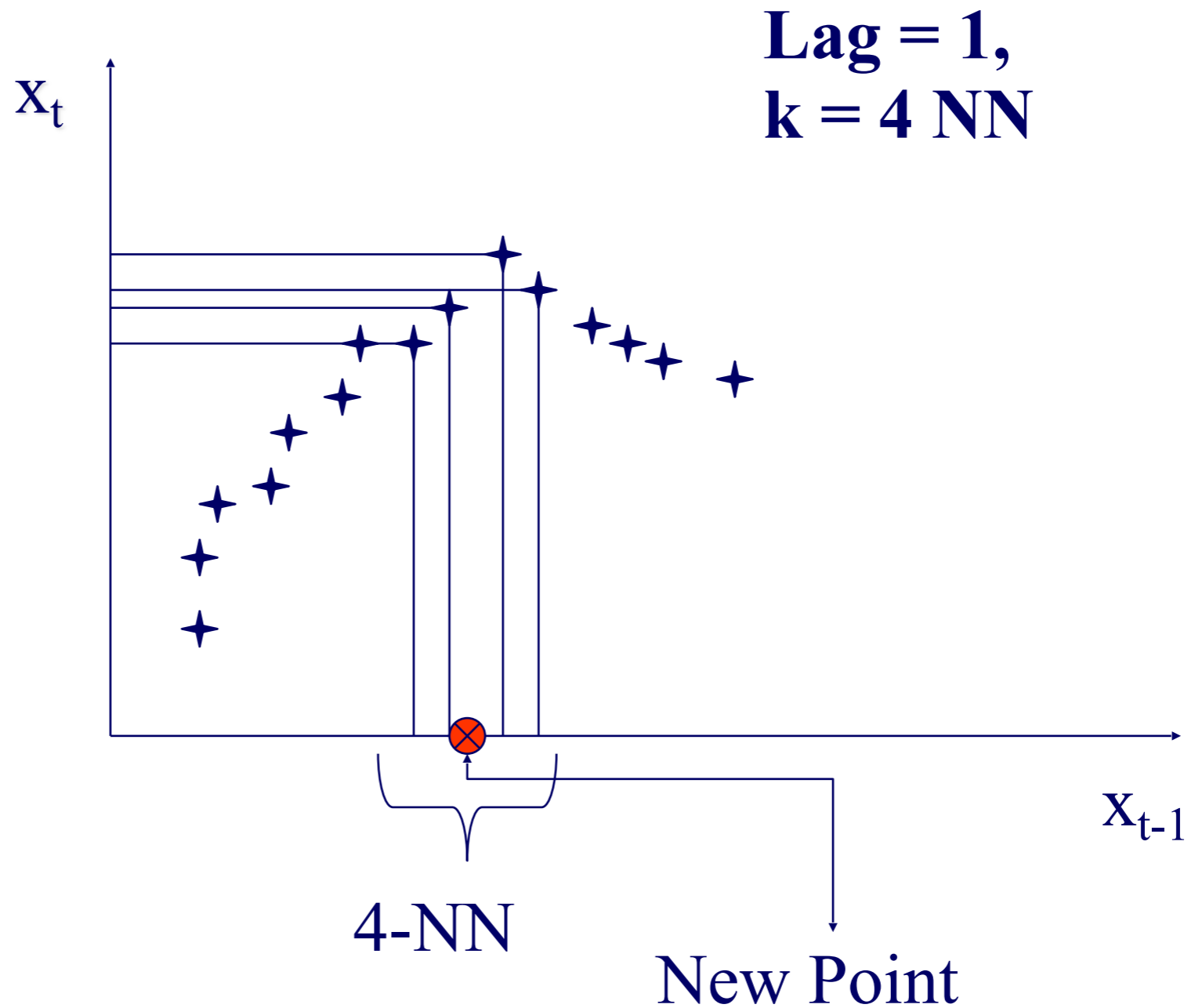

General Intuition (Lag Plot)

Interpolate these...

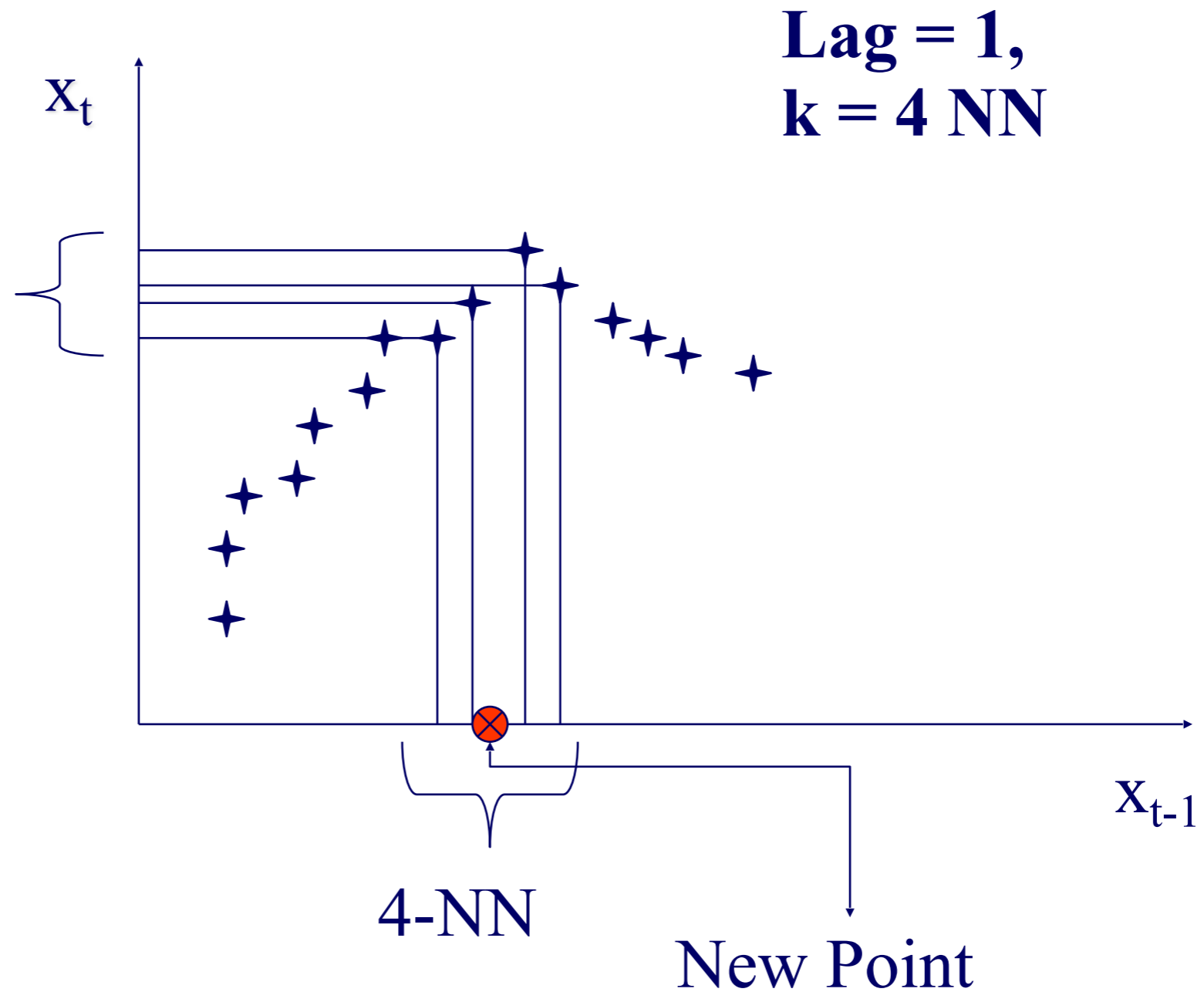

General Intuition (Lag Plot)

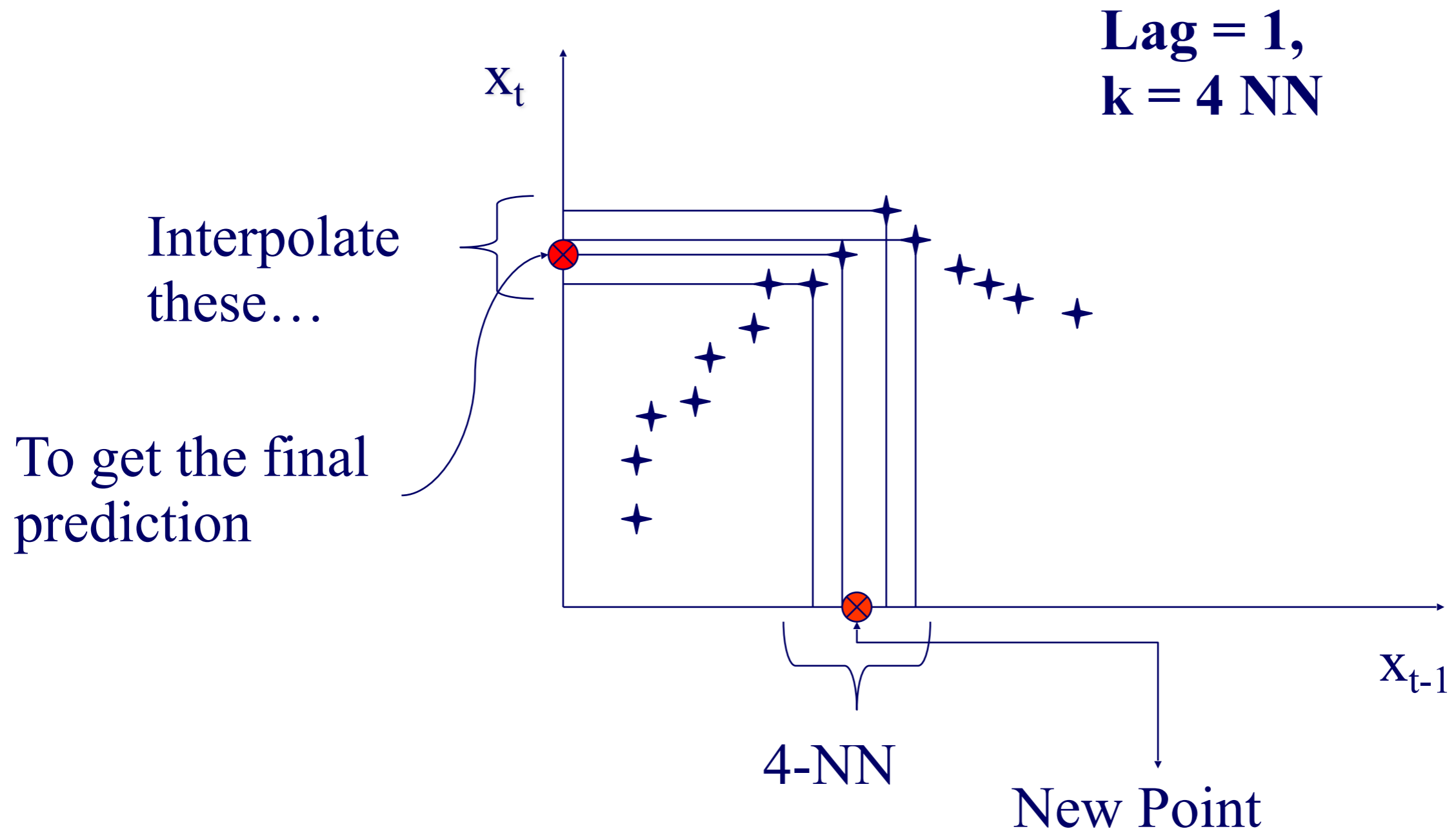

Questions:

- Q1: How to choose lag L ?
- Q2: How to choose k (the # of NN)?
- Q3: How to interpolate?
- Q4: why should this work at all?

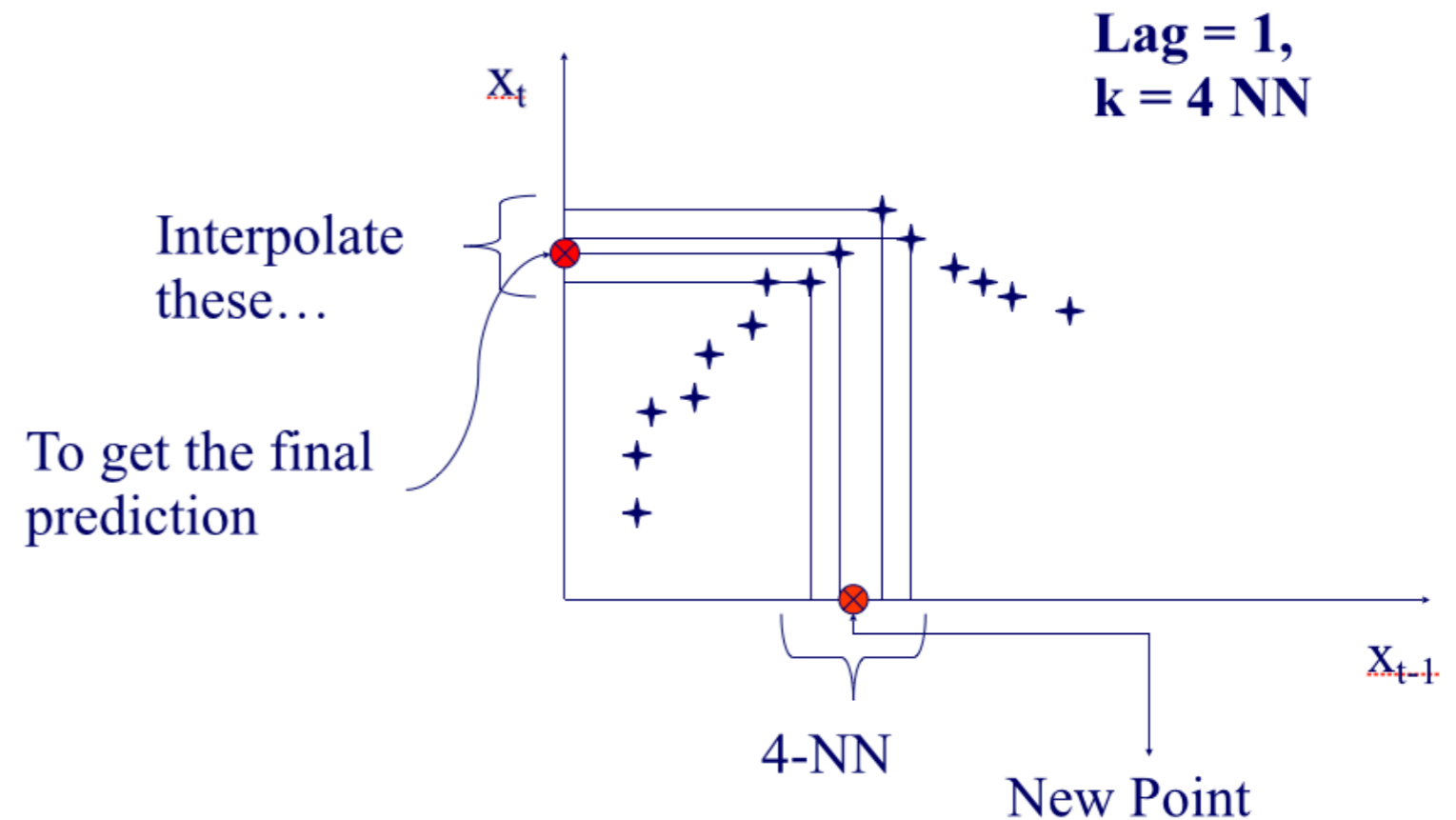

Q1: Choosing lag L

- Manually (16, in award winning system by [Sauer94])

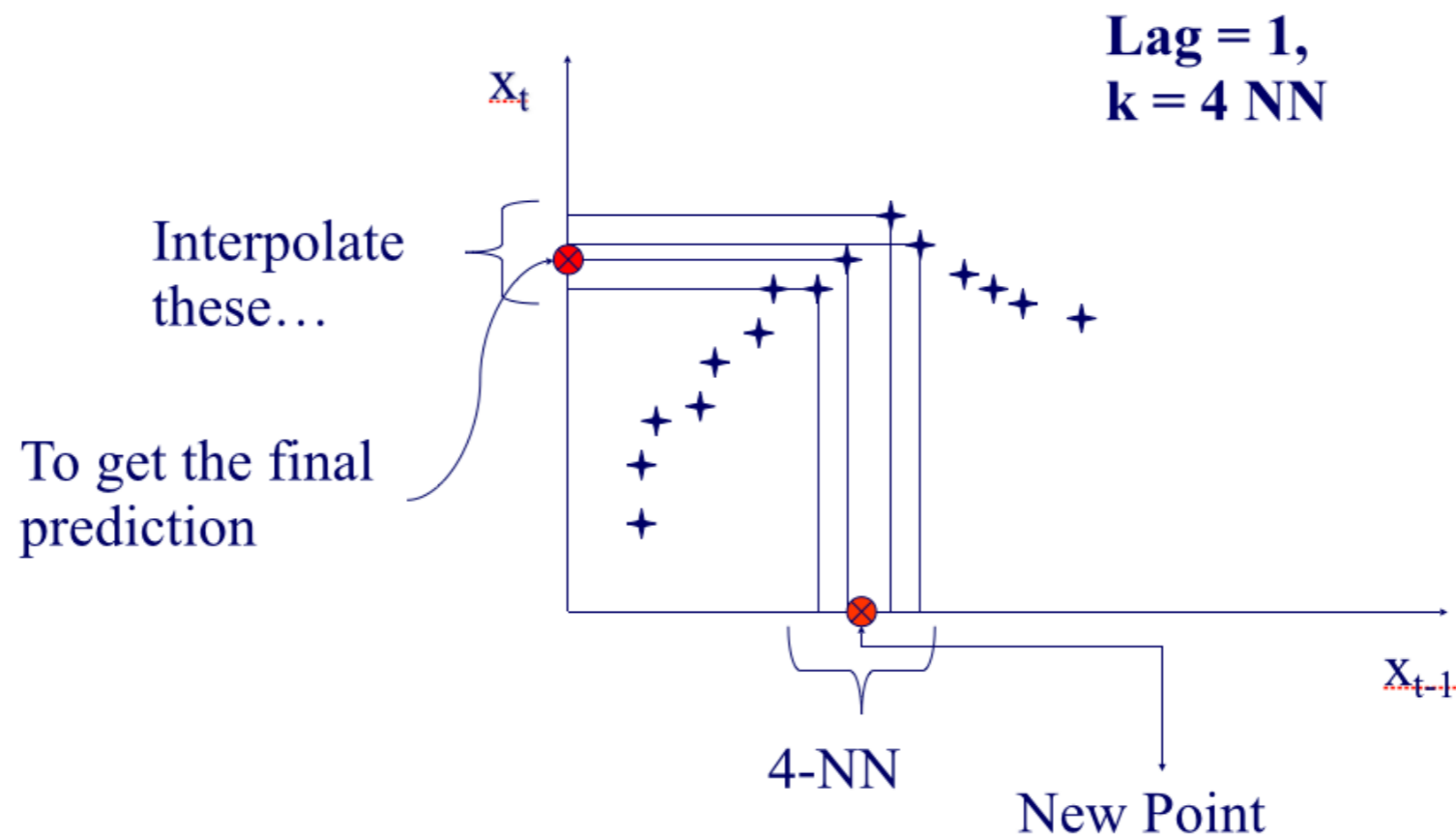

Q2: Choosing number of neighbors k

- Manually (typically $\sim 1-10$)

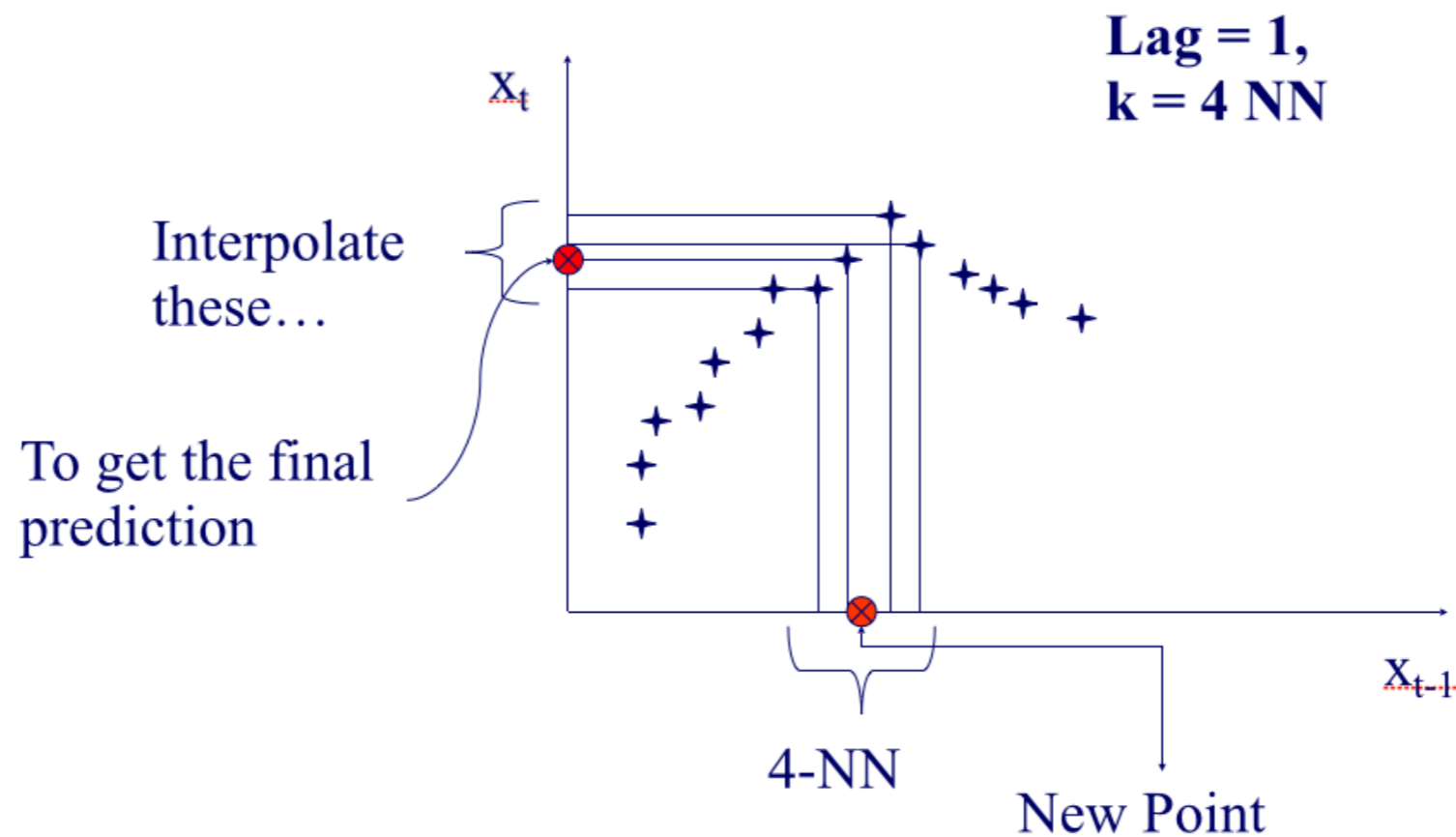

Q3: How to interpolate?

How do we interpolate between the k nearest neighbors?

A3.1: Average

A3.2: Weighted average (weights drop with distance - how?)

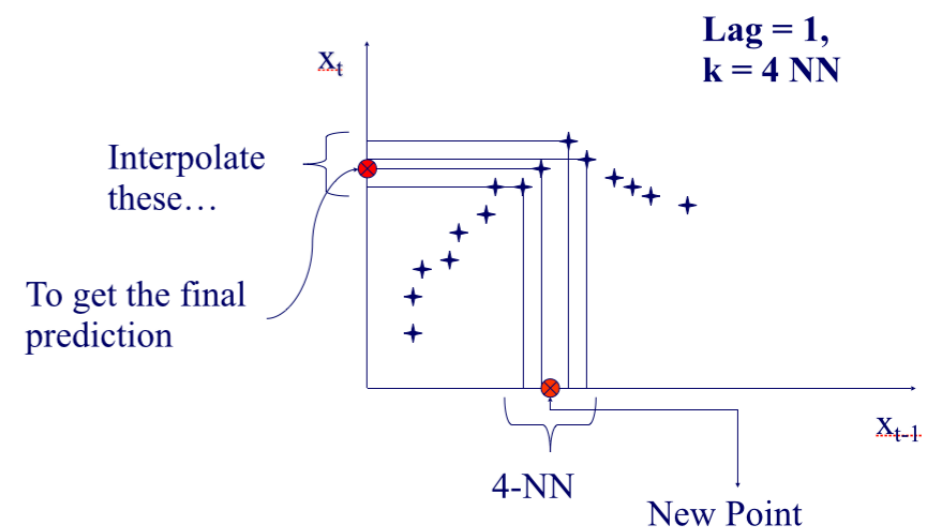

Q3: How to interpolate?

A3.3: Using SVD - seems to perform best
([Sauer94] - first place in the Santa Fe
forecasting competition)

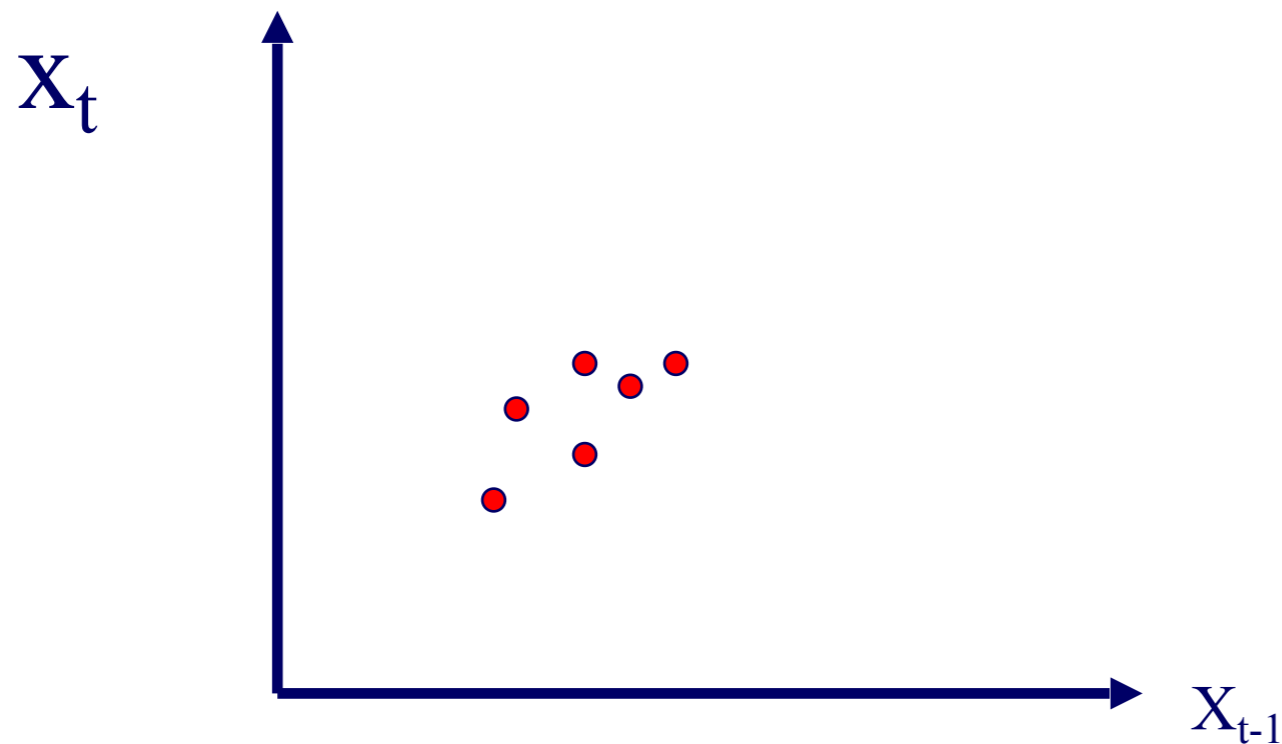

Q3: How to interpolate?

A3.3: Using SVD - seems to perform best
([Sauer94] - first place in the Santa Fe
forecasting competition)

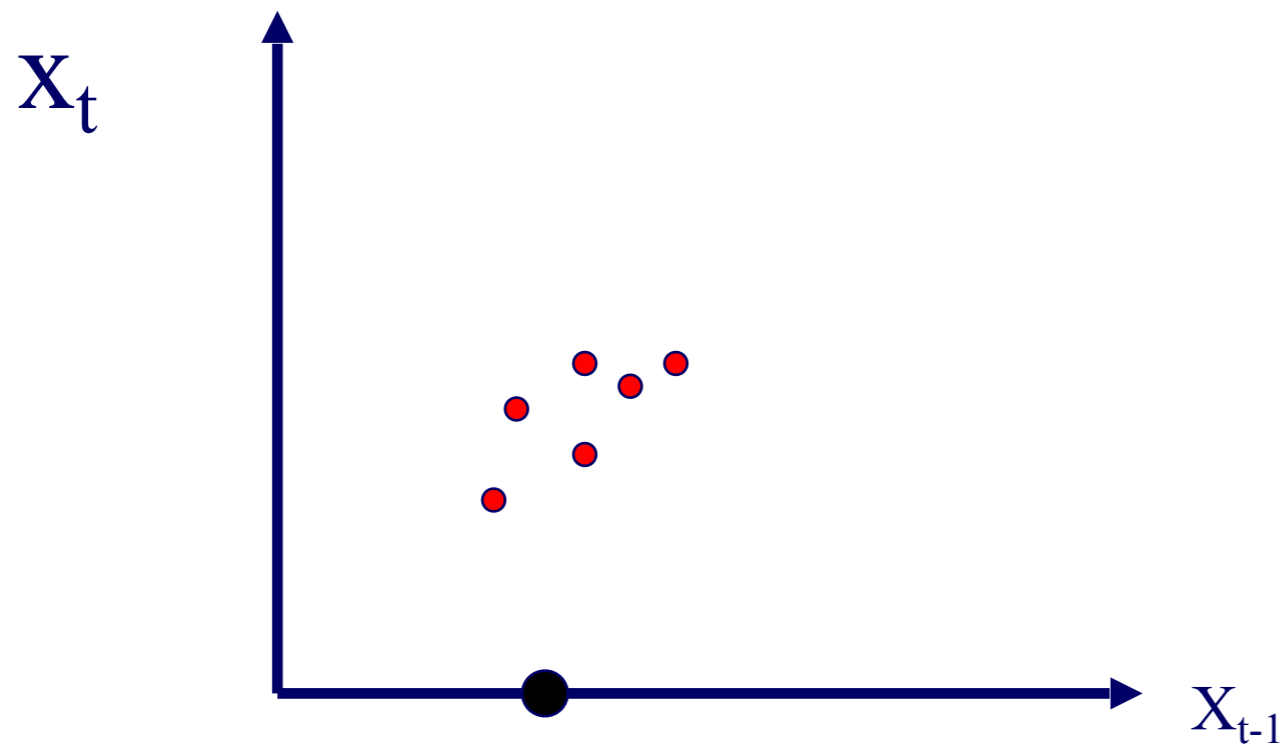

Q3: How to interpolate?

A3.3: Using SVD - seems to perform best
([Sauer94] - first place in the Santa Fe
forecasting competition)

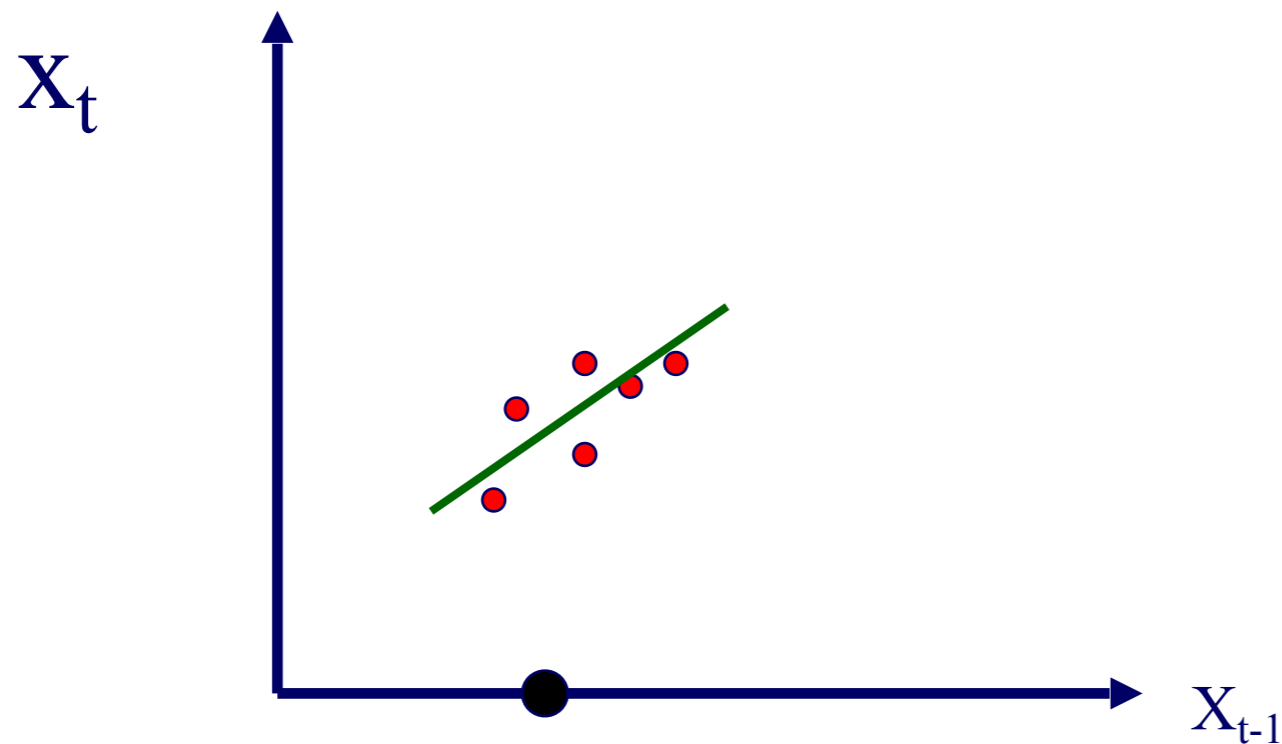

Q3: How to interpolate?

A3.3: Using SVD - seems to perform best
([Sauer94] - first place in the Santa Fe
forecasting competition)

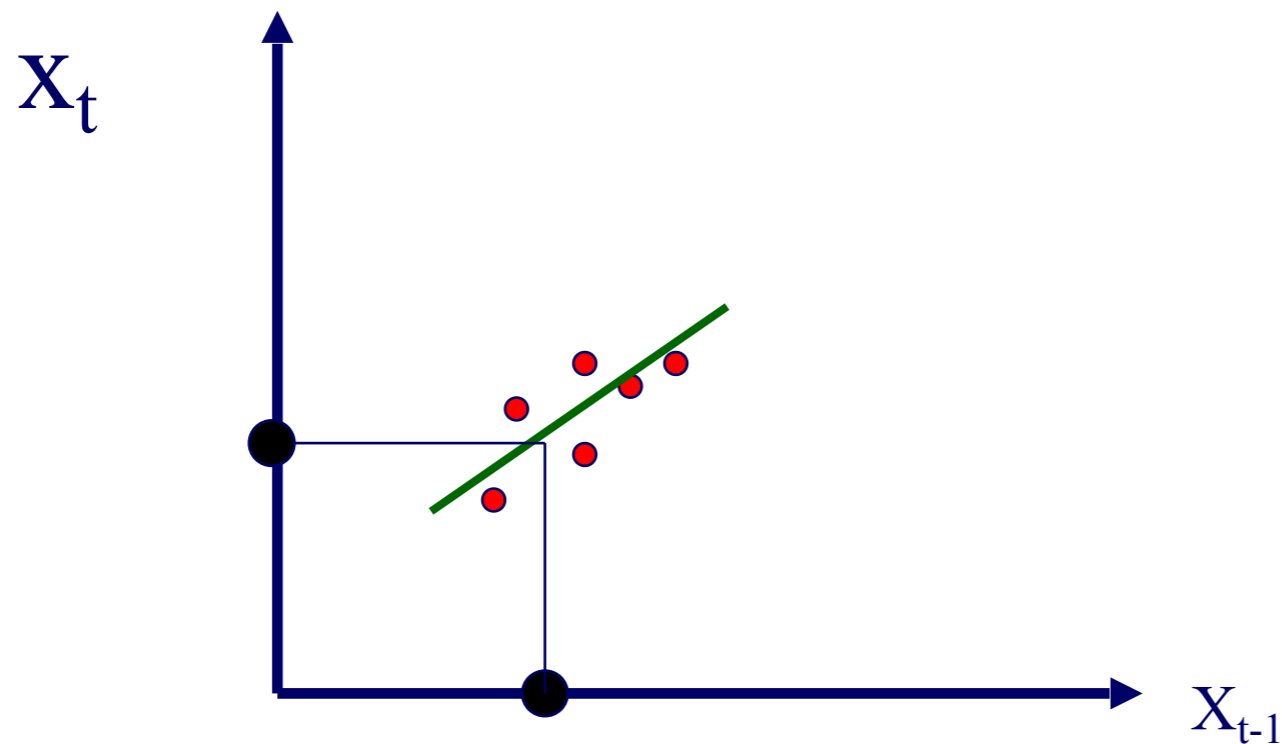

Q4: Any theory behind it?

A4: YES!

Theoretical foundation

- Based on the ‘Takens theorem’ [Takens81]
- which says that long enough delay vectors can do prediction, even if there are unobserved variables in the dynamical system (= diff. equations)

Detailed Outline

- Non-linear forecasting
 - Problem
 - Idea
 - How-to
 - Experiments
 - Conclusions

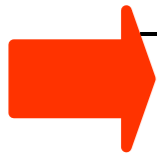

Logistic Parabola

Our Prediction from here

Value

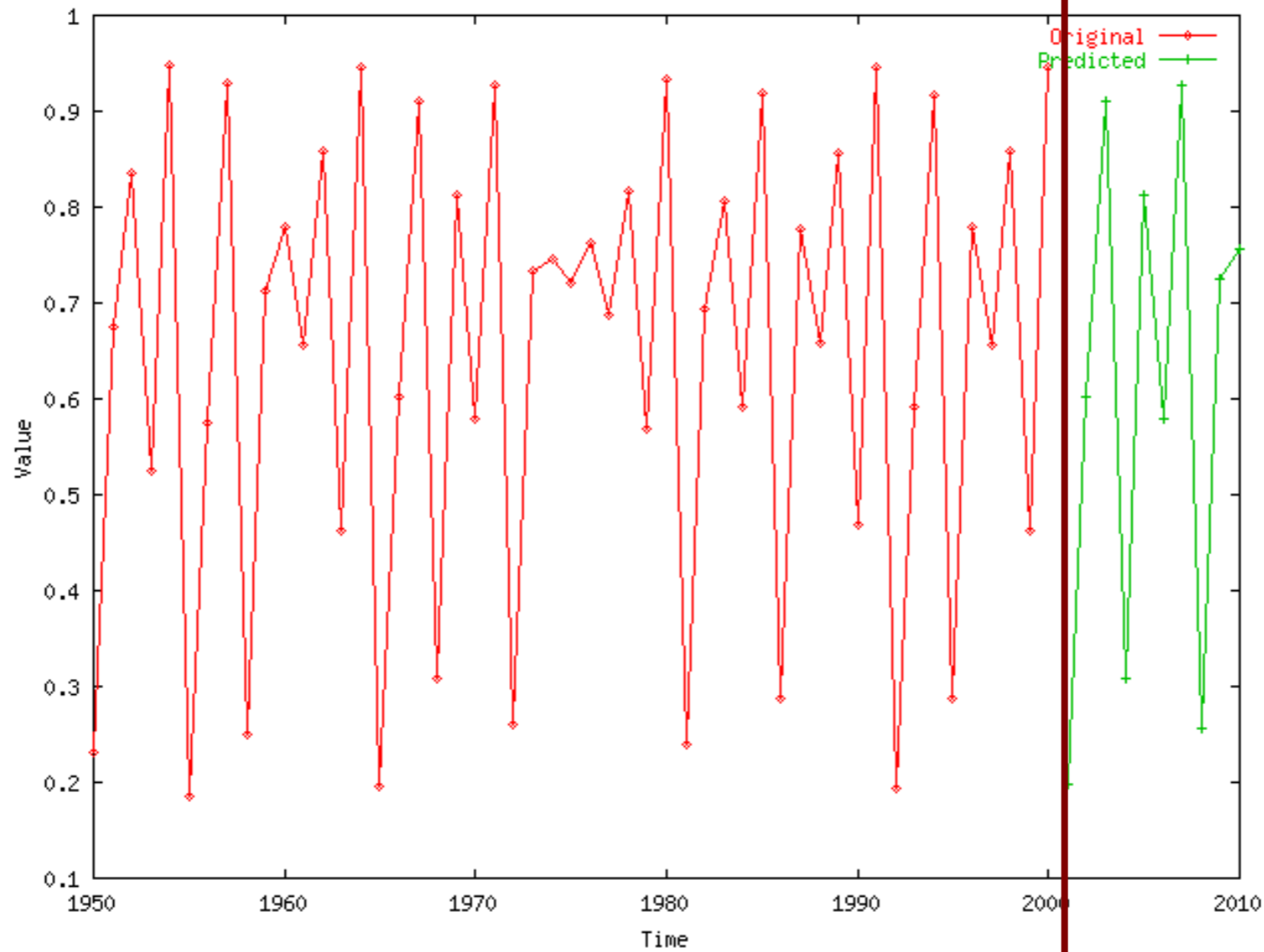

Timesteps

Value

Logistic Parabola

Comparison of prediction to correct values

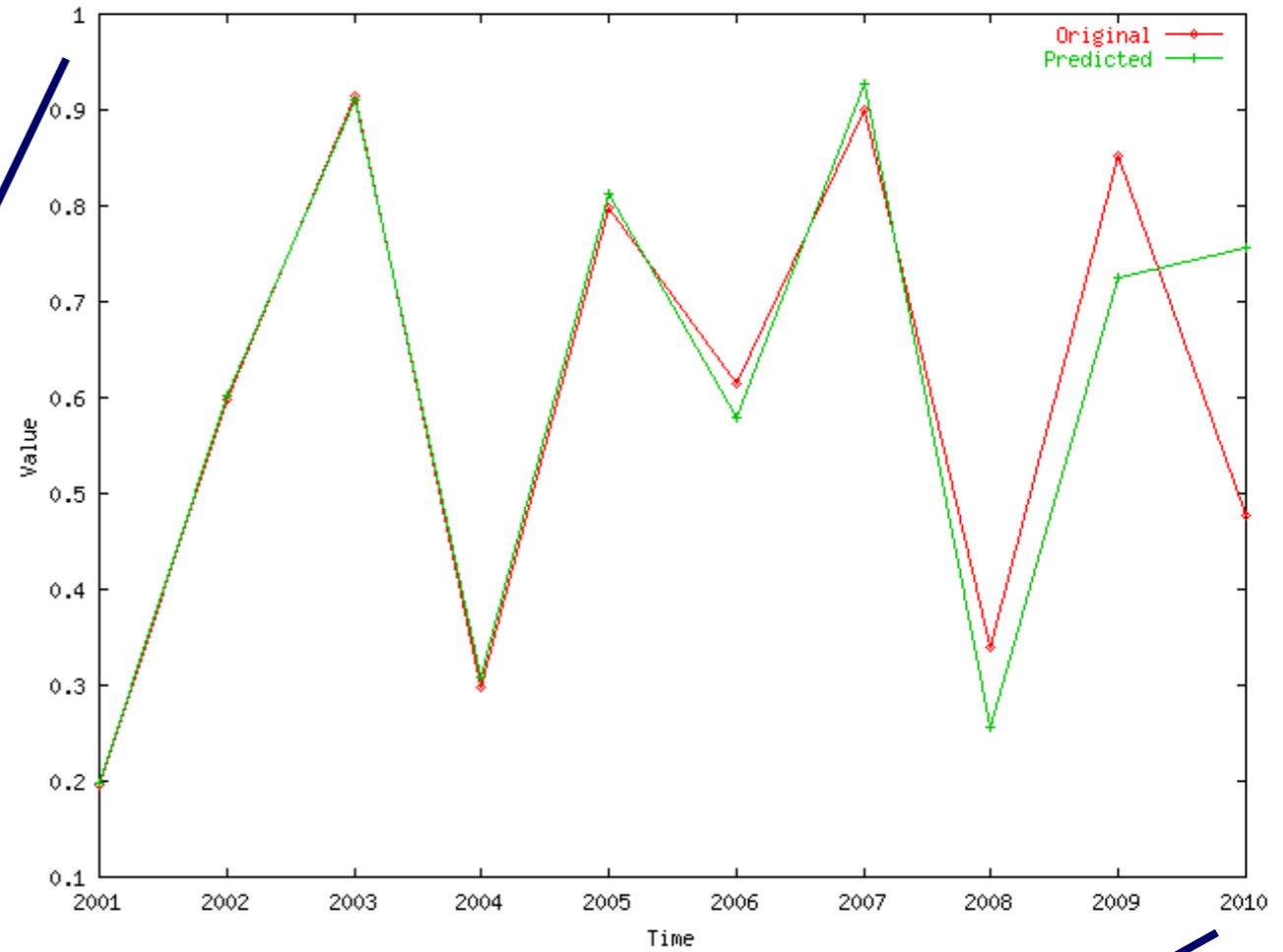
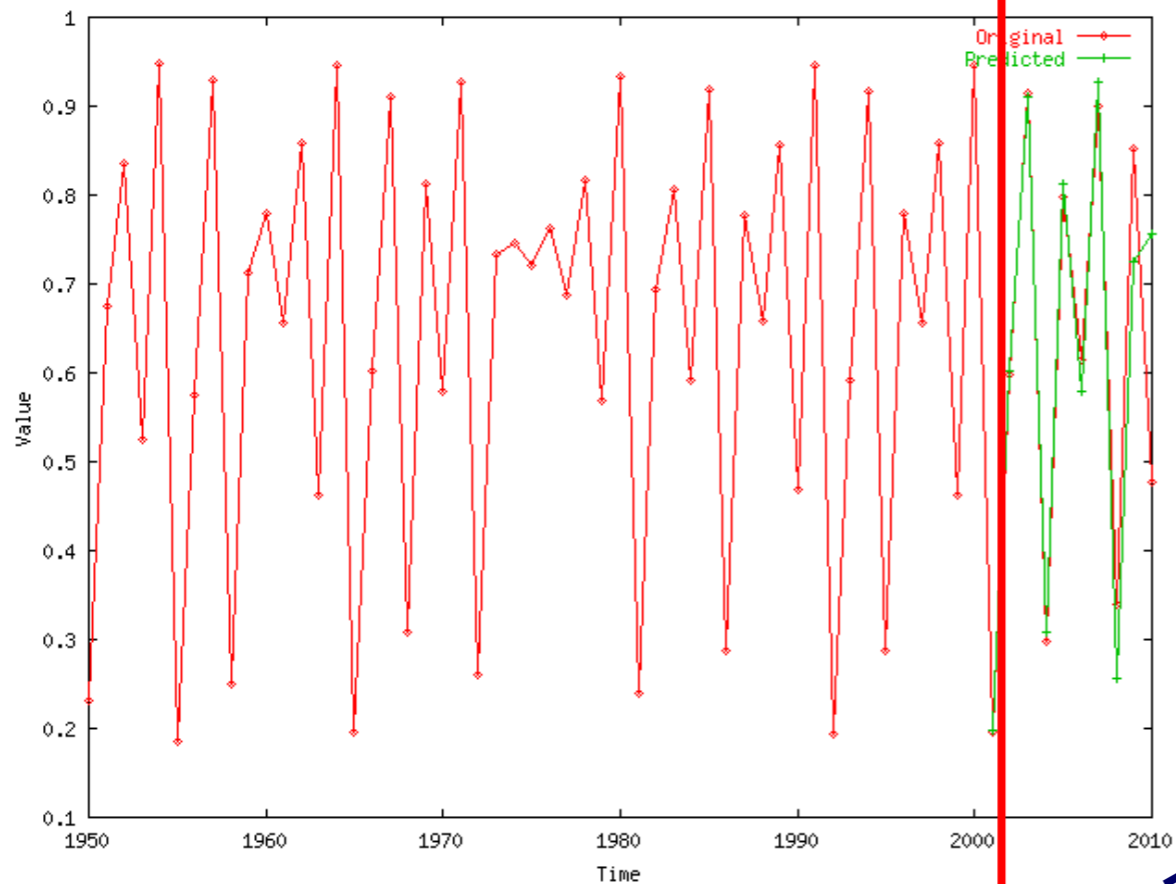

Timesteps

Value

Datasets

LORENZ: Models convection
currents in the air

$$dx / dt = a (y - x)$$

$$dy / dt = x (b - z) - y$$

$$dz / dt = xy - c z$$

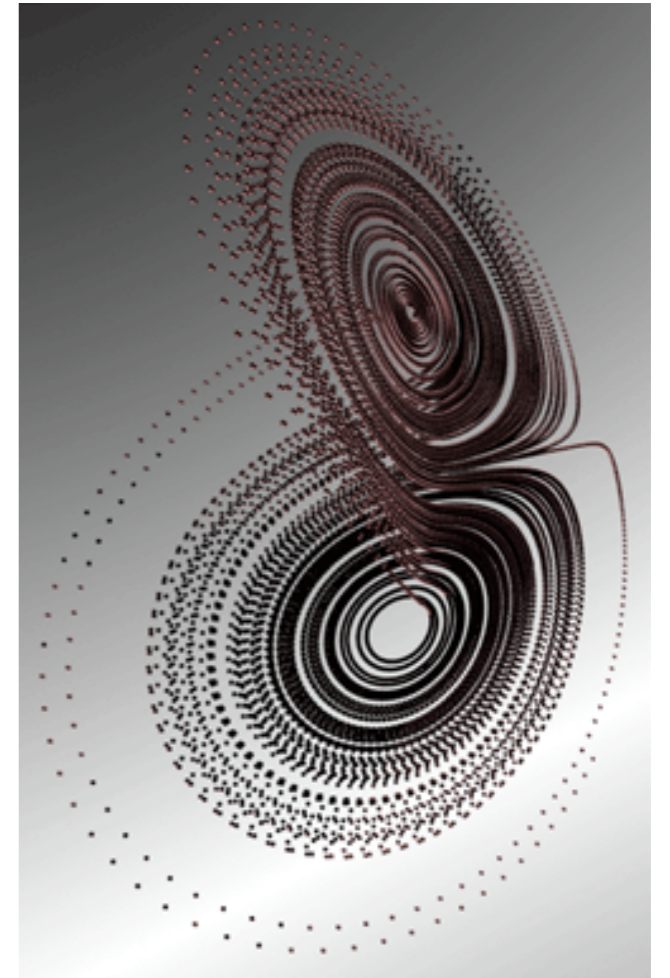
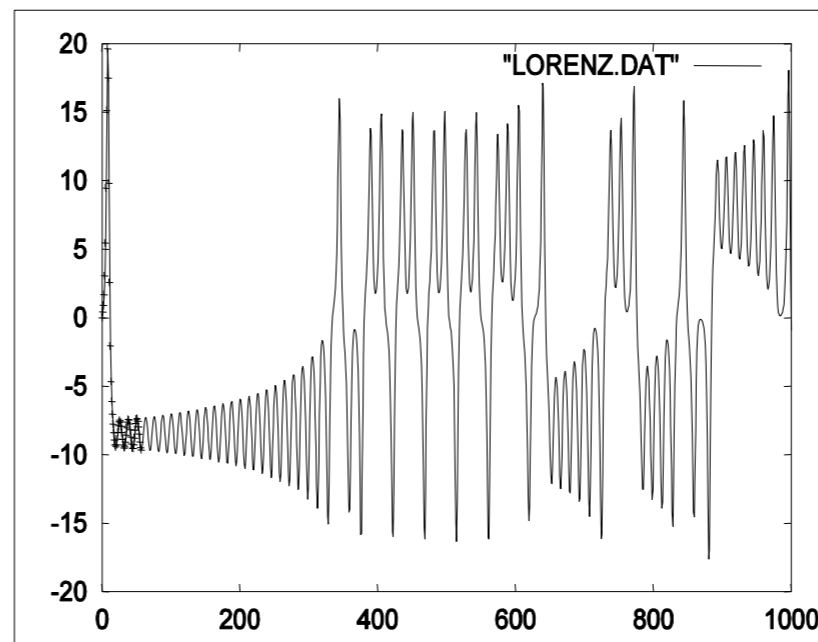

LORENZ

Comparison of prediction to correct values

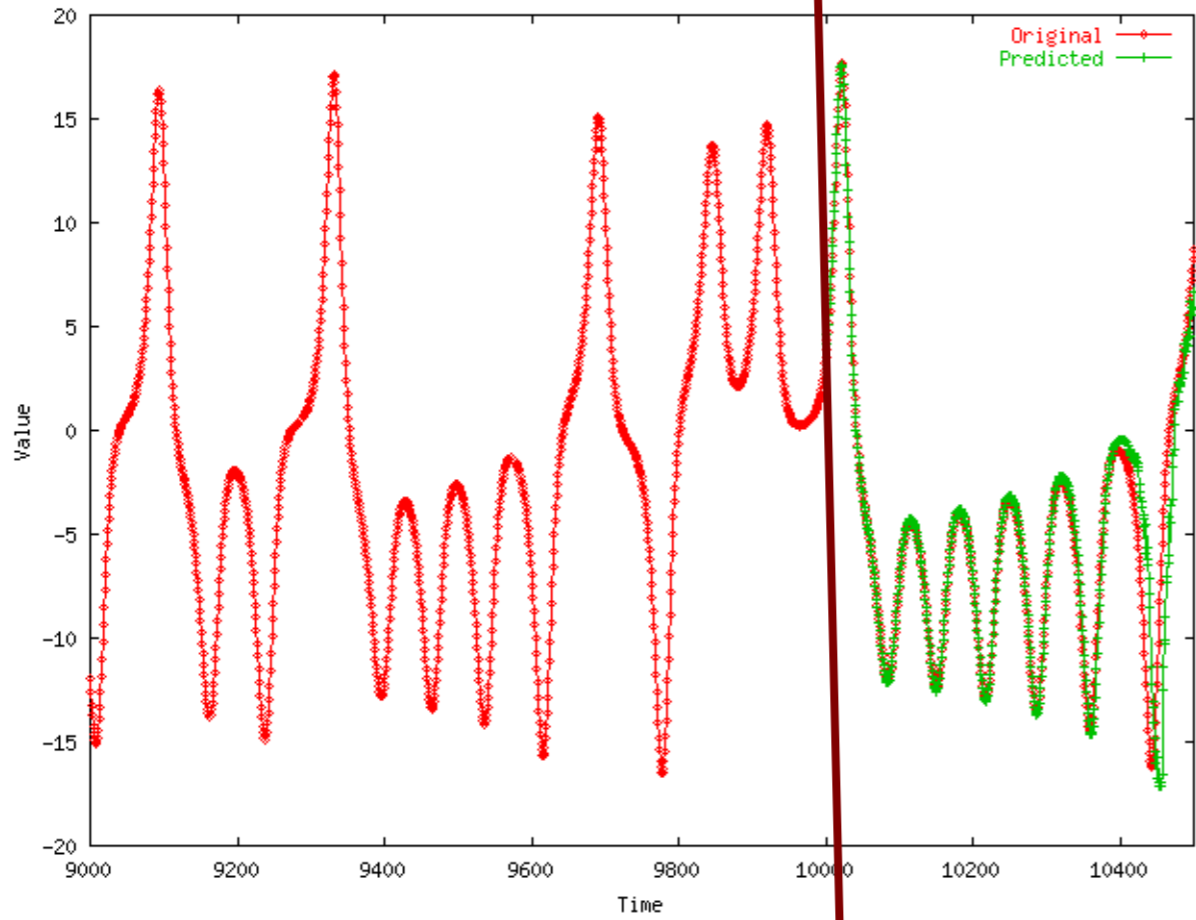

Value

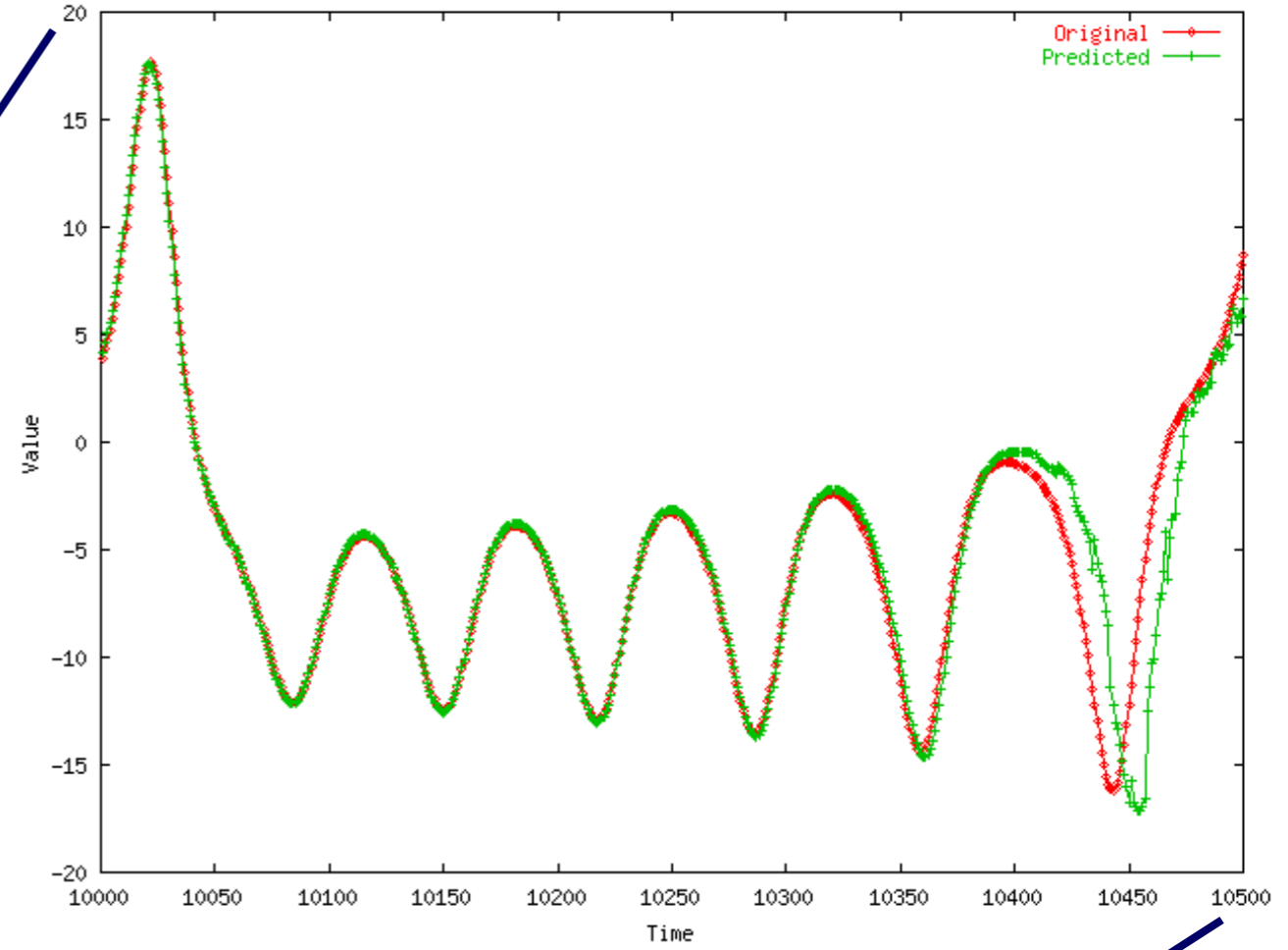

Timesteps

Value

Datasets

- LASER: fluctuations in a Laser over time (used in Santa Fe competition)

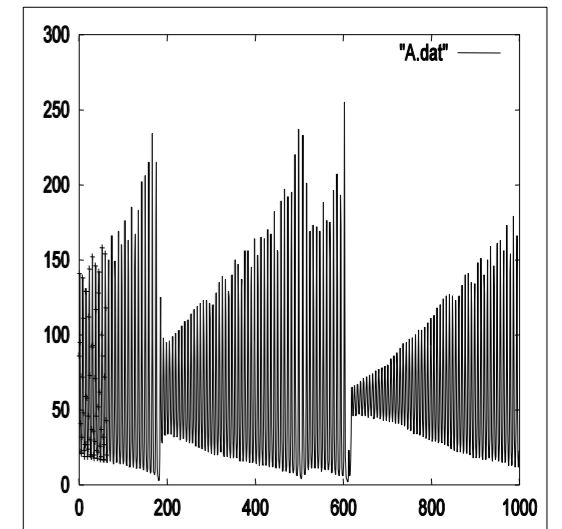

Time

Laser

Comparison of prediction to correct values

Value

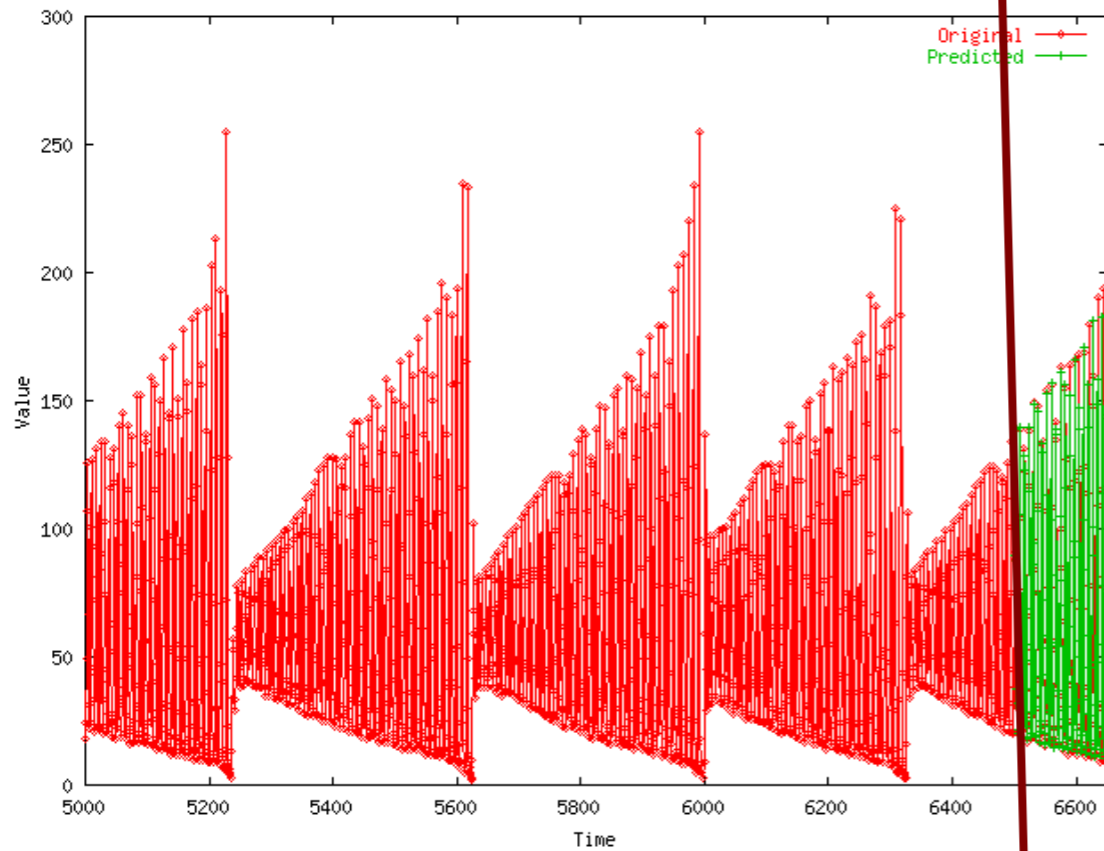
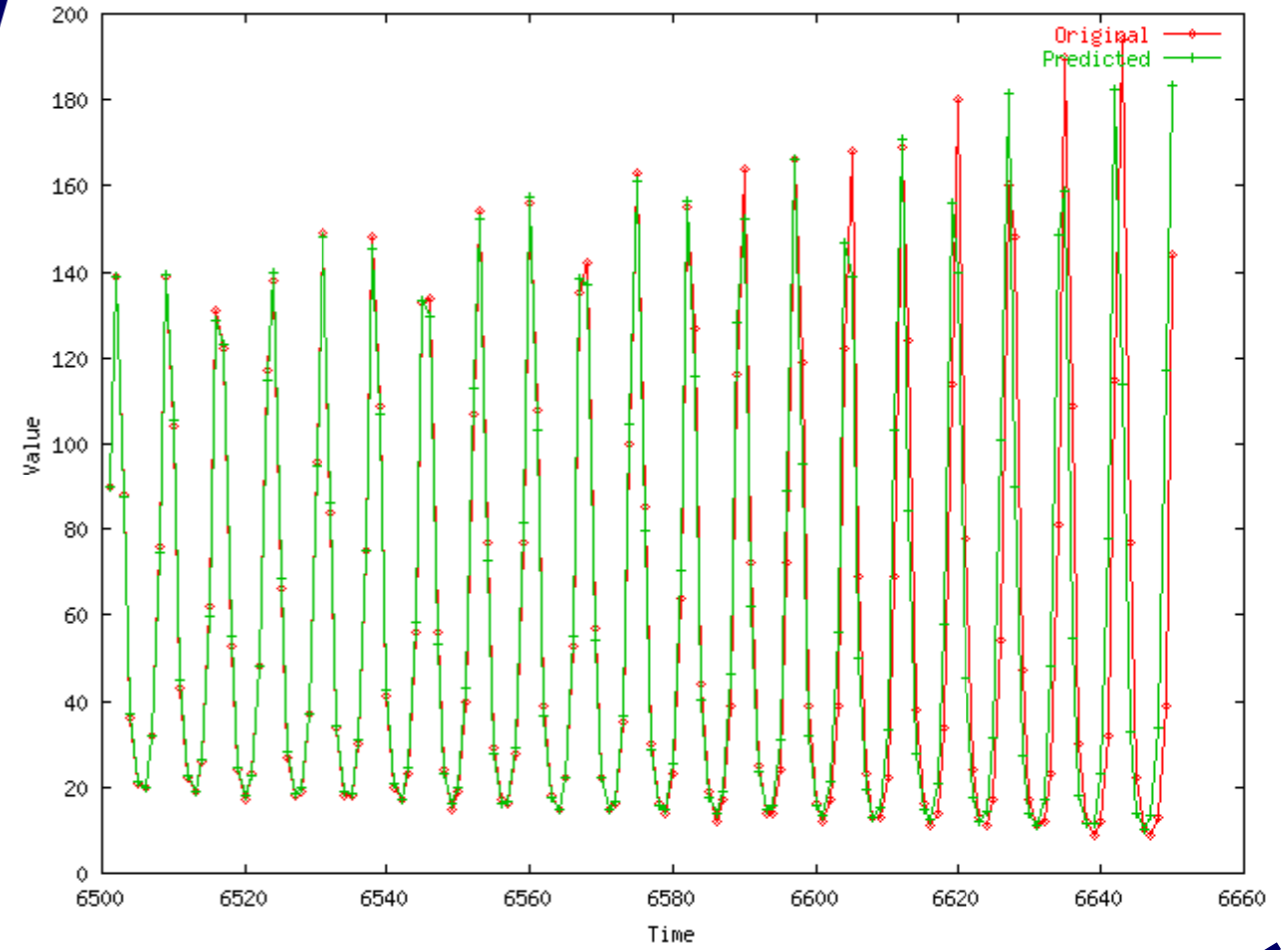

Timesteps

Conclusions

- Lag plots for non-linear forecasting (Takens' theorem)
- suitable for 'chaotic' signals

References

- Deepay Chakrabarti and Christos Faloutsos *F4: Large-Scale Automated Forecasting using Fractals* CIKM 2002, Washington DC, Nov. 2002.
- Sauer, T. (1994). *Time series prediction using delay coordinate embedding*. (in book by Weigend and Gershenfeld, below) Addison-Wesley.
- Takens, F. (1981). *Detecting strange attractors in fluid turbulence*. *Dynamical Systems and Turbulence*. Berlin: Springer-Verlag.

References

- Weigend, A. S. and N. A. Gerschenfeld (1994). *Time Series Prediction: Forecasting the Future and Understanding the Past*, Addison Wesley. (Excellent collection of papers on chaotic/non-linear forecasting, describing the algorithms behind the winners of the Santa Fe competition.)

Overall conclusions

- Similarity search: **Euclidean/time-warping; feature extraction and SAMs**
- Linear Forecasting: **AR (Box-Jenkins) methodology;**
- Non-linear forecasting: **lag-plots (Takens)**

Must-Read Material

- Byong-Kee Yi, Nikolaos D. Sidiropoulos, Theodore Johnson, H.V. Jagadish, Christos Faloutsos and Alex Biliris, *Online Data Mining for Co-Evolving Time Sequences*, ICDE, Feb 2000.
- Chungmin Melvin Chen and Nick Roussopoulos, *Adaptive Selectivity Estimation Using Query Feedbacks*, SIGMOD 1994

Time Series Visualization + Applications

Apple Inc. (NASDAQ:AAPL)

Add to portfolio

171.10 +2.02 (1.19%)

After Hours: 171.16 +0.06 (0.04%)

Nov 16, 4:20PM EST

NASDAQ real-time data - Disclaimer

Currency in USD

Range	170.30 - 171.87	Div/yield	0.63/1.47
52 week	106.60 - 176.24	EPS	9.19
Open	171.18	Shares	5.13B
Vol / Avg.	23.52M/26.43M	Beta	1.25
Mkt cap	878.48B	Inst. own	61%
P/E	18.63		

G+



Settings | Technicals | [Link to this view](#)

Volume delayed by 15 mins.

How to build time series visualization?

Easy way: use existing tools, libraries

- **Google Public Data Explorer (Gapminder)**

<http://goo.gl/HmrH>

- **Google acquired Gapminder**

<http://goo.gl/43avY>

(Hans Rosling's **TED talk** <http://goo.gl/tKV7>)

- **Google Annotated Time Line**

<http://goo.gl/Upm5W>

- **Timeline**, from MIT's SIMILE project

<http://simile-widgets.org/timeline/>

- **Timeplot**, also from SIMILE

<http://simile-widgets.org/timeplot/>

- **Excel**, of course

How to build time series visualization?

The harder way:

- Cross filter. <http://square.github.io/crossfilter/>
- R (ggplot2)
- Matlab
- gnuplot
- **seaborn** <https://seaborn.pydata.org>

The even harder way:

- D3, for web
- JFreeChart (Java)
- ...

Time Series Visualization

Why is it useful?

When is visualization useful?

(Why not automate everything? Like using the forecasting techniques you learned last time.)

Time Series User Tasks

- When was something greatest/least?
- Is there a pattern?
- Are two series similar?
- Do any of the series match a pattern?
- Provide simpler, faster access to the series
- Does data element exist at time t ?
- When does a data element exist?
- How long does a data element exist?
- How often does a data element occur?
- How fast are data elements changing?
- In what order do data elements appear?
- Do data elements exist together?



Water Consumption in Edmonton During Olympic Gold Medal Hockey Game

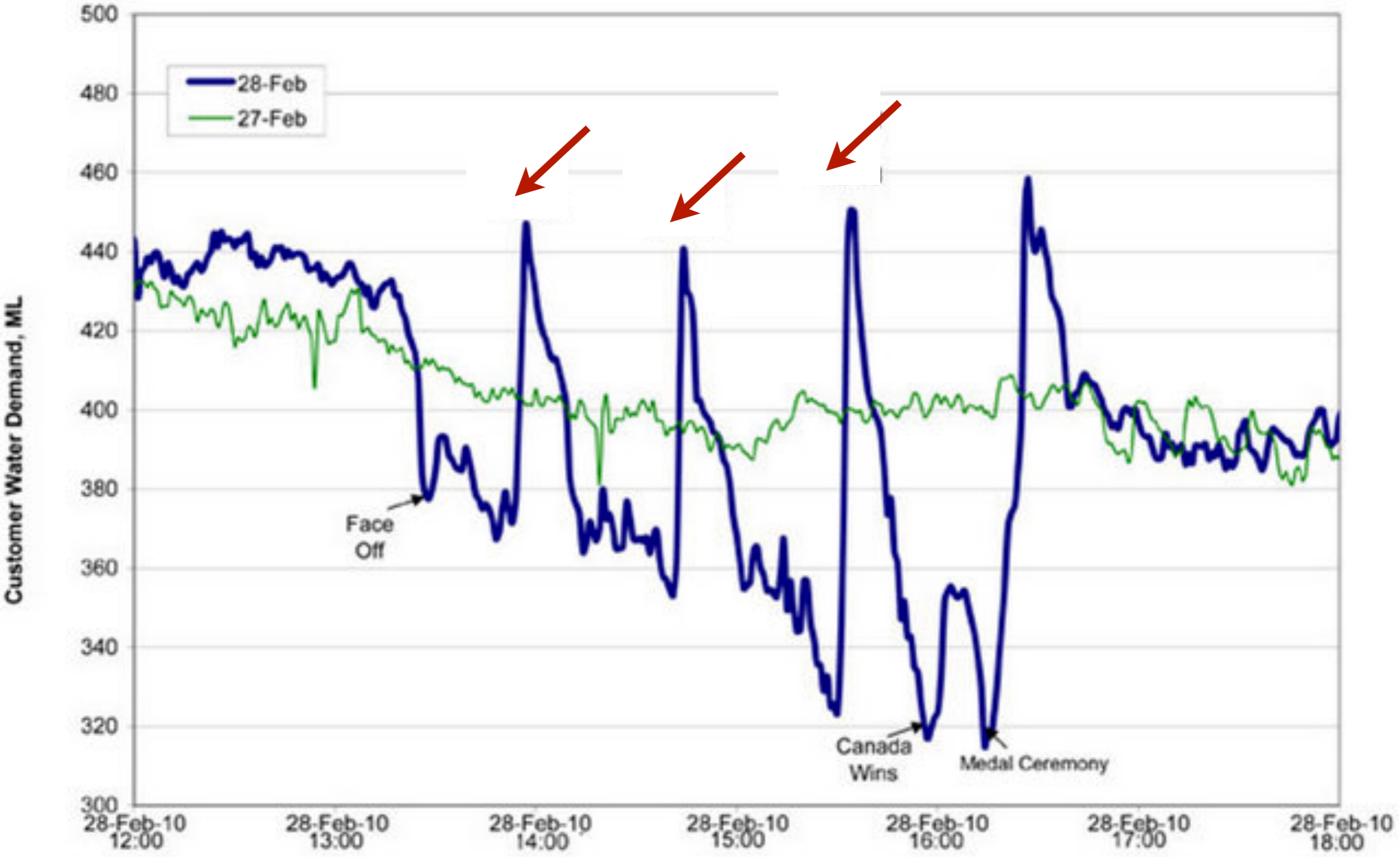

Water Consumption in Edmonton During Olympic Gold Medal Hockey Game

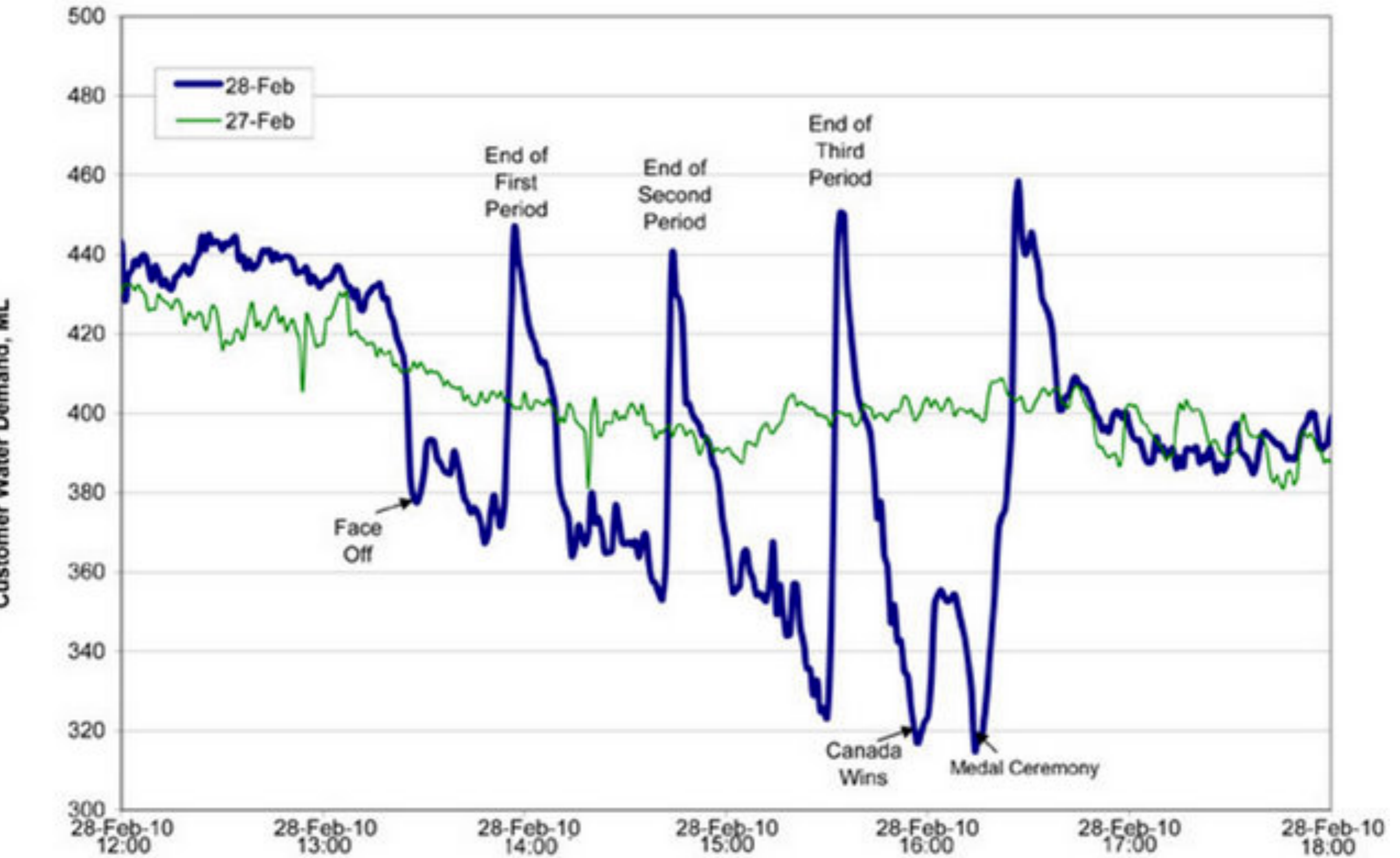

Gantt Chart

Useful for project

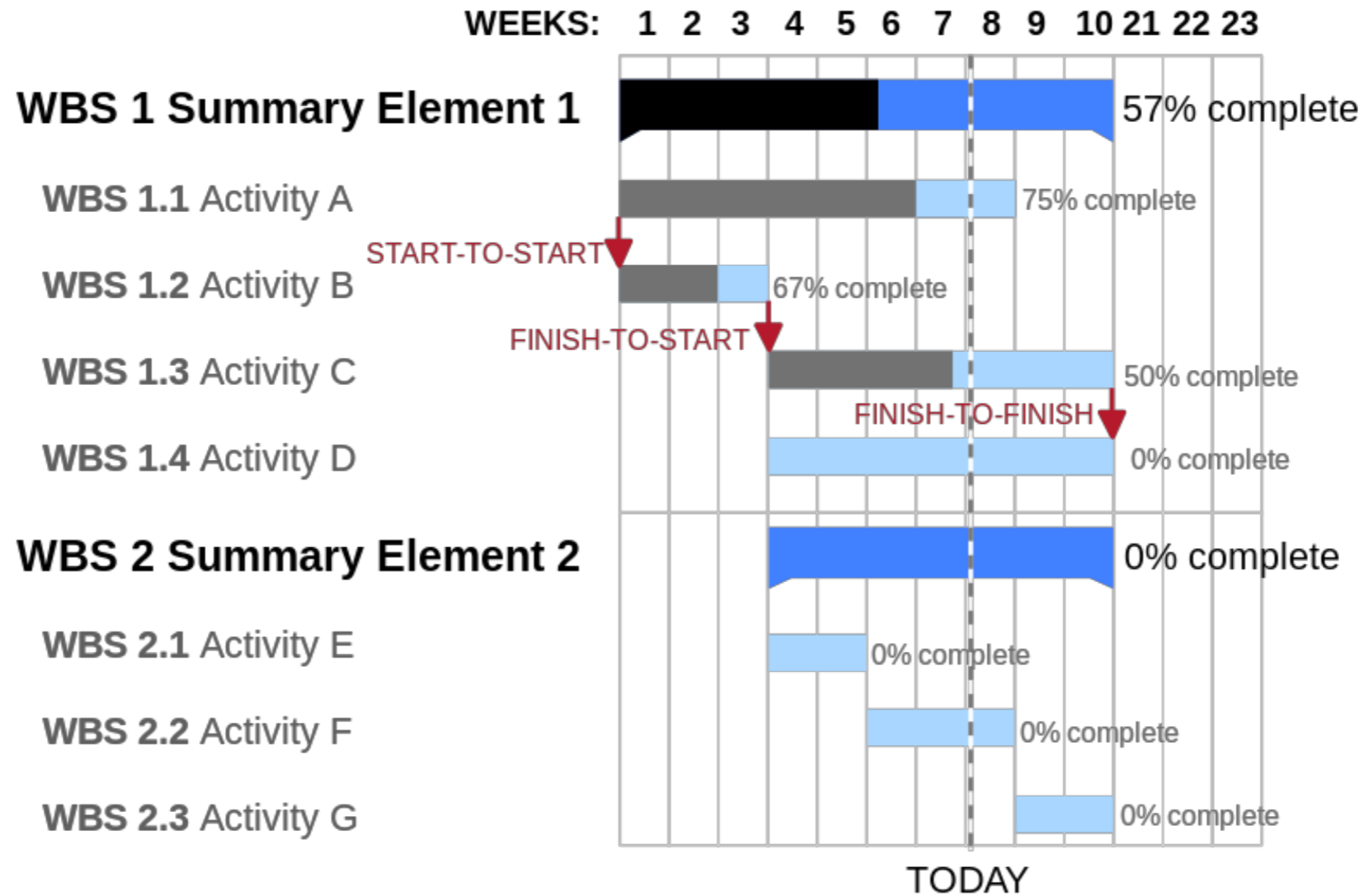

How to create in Excel:

<http://www.youtube.com/watch?v=sA67g6zaKOE>

TimeSearcher

support queries

Can create rectangles that function as matching regions

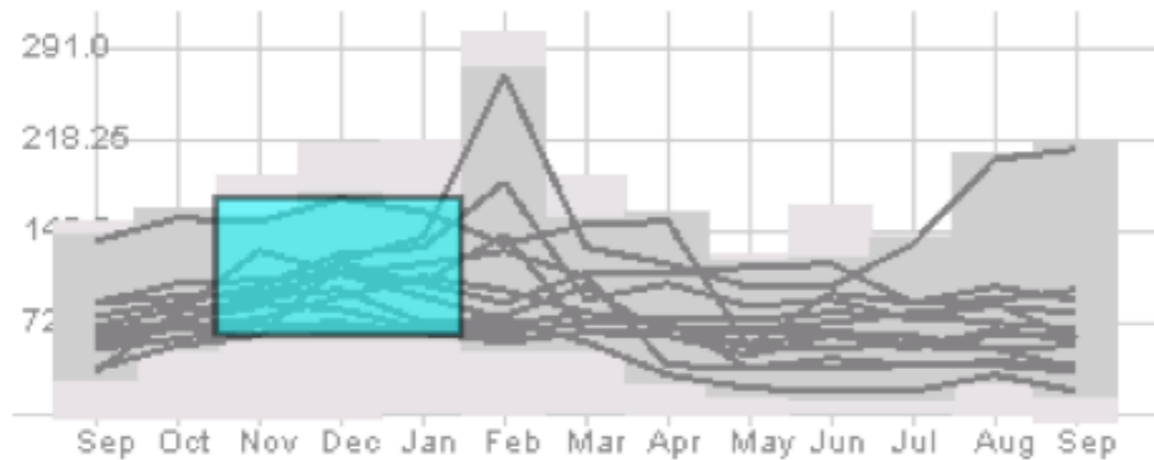
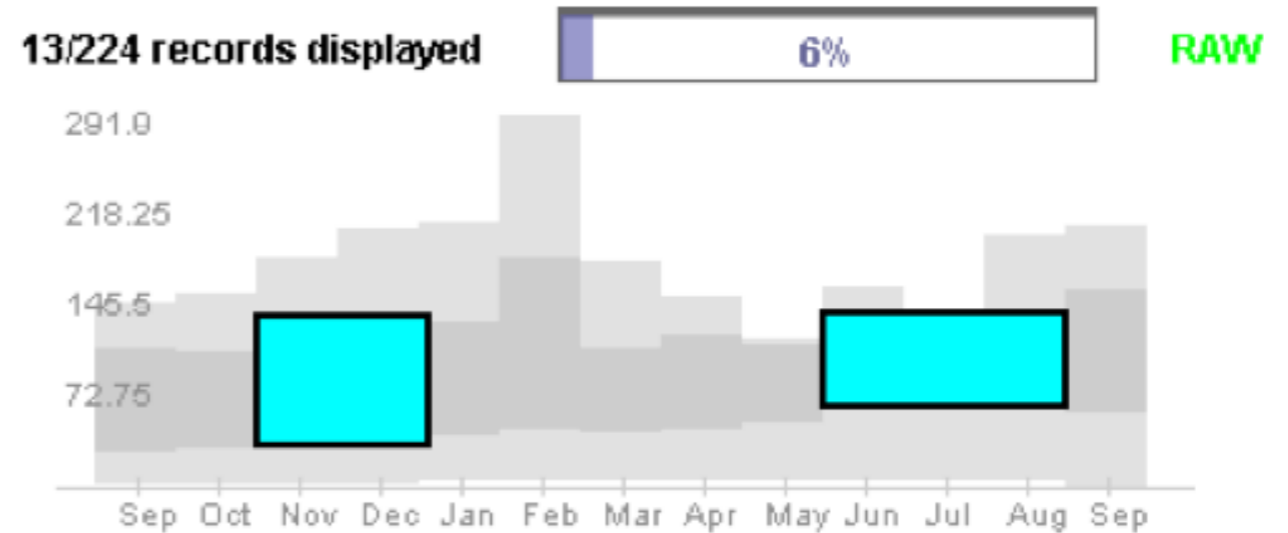

Light gray is all data's extent

Darker grayed region is data envelope that shows extreme values of queries matching criteria

Multiple boxes are "anded"

Hochheiser & Shneiderman
Proc. Discovery Science '01

GeoTime

Infovis 2004

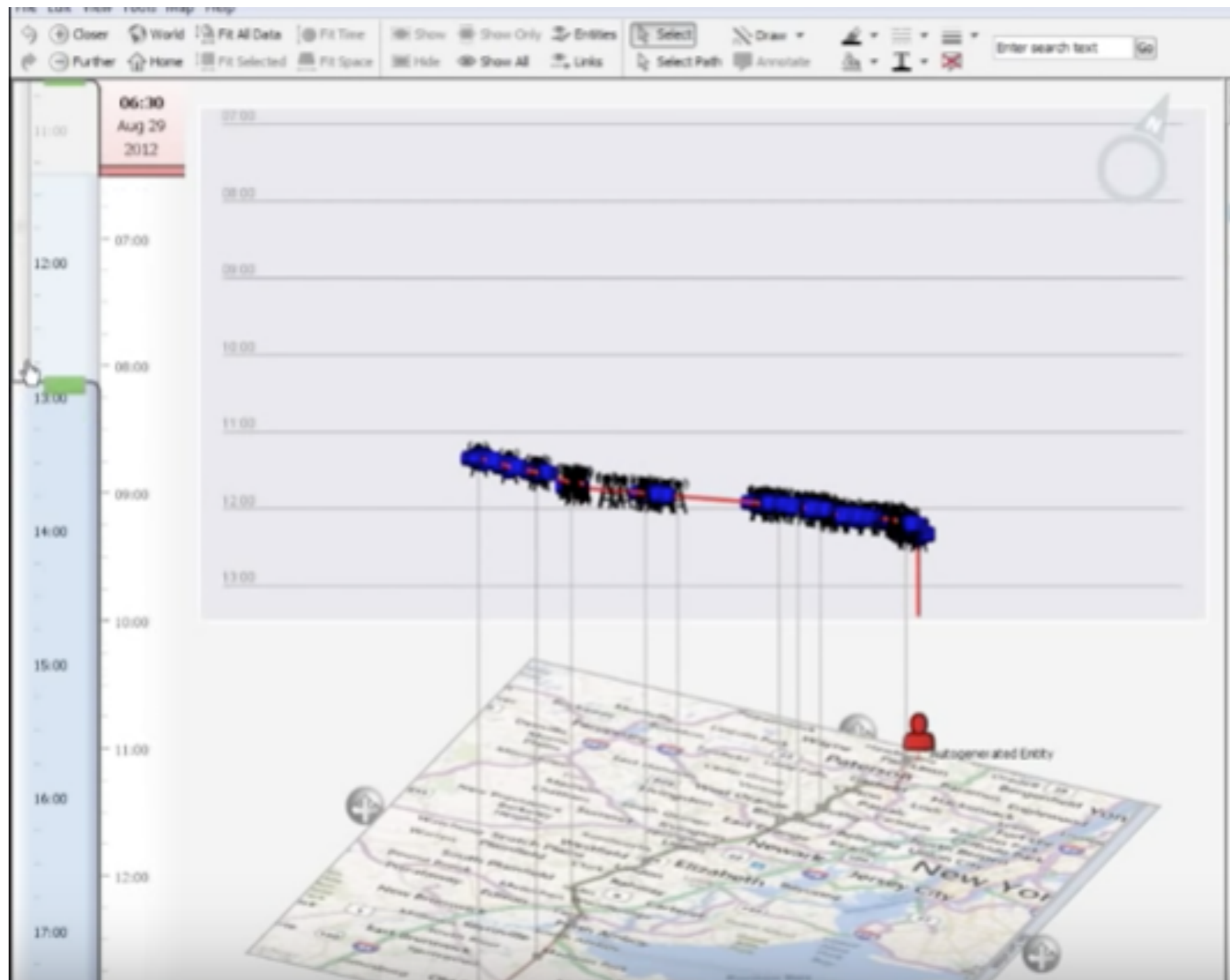

<https://youtu.be/inkF86QJBdA?t=2m51s>

<http://vadl.cc.gatech.edu/documents/>

[55_Wright_KaplerWright_GeoTime_InfoViz_Jrnl_05_send.pdf](#)